

morsø



By appointment to The Royal Danish Court

**morsø**

## Instructions for installation and use

# 6600 series

AS/NZS 4012/4013 (2014)

Morsø 6643 & 6670



Read this entire manual before you install and use your new room heater. If this room heater is not properly installed, a house fire may result. To reduce the risk of fire, follow the installation instructions. Failure to follow instructions may result in property damage, bodily injury, or even death.

Contact local building officials about restrictions and installation inspection-requirements in your area.

Save these instructions

Distributed by: Castworks · 8 Roosevelt St.  
North Coburg · VIC 3058 · Australia

[www.morsoe.com](http://www.morsoe.com)

## Enjoy your new Morsø stove!

Morsø, the biggest stove company in the Danish market, has been making wood-burning stoves of the highest quality since 1853. Just follow the instructions below, and we are certain that you will be able to use and enjoy your new stove for many years.

### Contents

		Page no
1.0	Installing your Morsø stove	
1.1	Unpacking the stove	3
1.2	Installing the stove	3
1.3	Chimney sweep	3
1.4	Location of the stove/distance requirements	3
1.5	The chimney	4
1.6	Pipe connections	5
1.7	Connecting to a brick chimney	6
1.8	Connecting to a steel chimney	6
1.9	Draught	8
2.0	Firing/using the stove	9
2.1	Lighting instructions and fuelling intervals	10
3.0	Routine stove maintenance	13
3.1	External maintenance	13
3.2	Internal maintenance	13
3.3	Cleaning the stove	14

### Additional accessories

We offer a comprehensive line of chimney, floor plate and accessory products that can facilitate the daily operation and maintenance of your Morsø stove.

## 1.0 Installing your Morsø stove

### 1.1 Unpacking the stove

The Morsø 6100 series weigh between 110 and 125 kg. In order to avoid damage when unpacking and assembling the stove, we recommend that this job be undertaken by two people.

### 1.2 Installing the stove

The stove is from the factory fitted with a top flue exit. The ball blocking device that is to stop the chimney sweep's ball during sweeping is also supplied with the stove and is installed at the same time as the smoke outlet.

National and local regulations regarding the installation of wood-burning stoves must be observed, as must local regulations regarding chimney connections and chimney installation. You may want to ask your chimney sweep for advice. However, you, your technical adviser or workman are responsible for complying with the applicable national and local regulations.

### 1.3 Chimney sweep

As stated, it may be wise to consult your local chimney sweep before installing the stove. In any event, the chimney sweep must be notified once the wood-burning stove has been installed. The chimney sweep will inspect the installation and schedule sweeping intervals with you. If your chimney has not been used for some time, it should be inspected for cracks, bird nests, etc., before it is used.

### 1.4 Location of the stove/distance requirements

Distance requirements apply only if the stove is placed near flammable materials. Your new stove can be positioned as specified on the table below if the walls are made of flammable material.

Minimum distances from flammable material:

Type of stove	installation type	Behind the stove (A)	To the sides of the stove (B)	To furniture
Morsø 6600 6" Triple skin flue kit	Parallel	275 mm	650 mm	800 mm
	Corner	-	300 mm	

The floorprotector consist of 6 mm thick cement fibre sheet which had a thermal resistance of 0,8 m<sup>2</sup> K/W, per 4 mm. thickness.

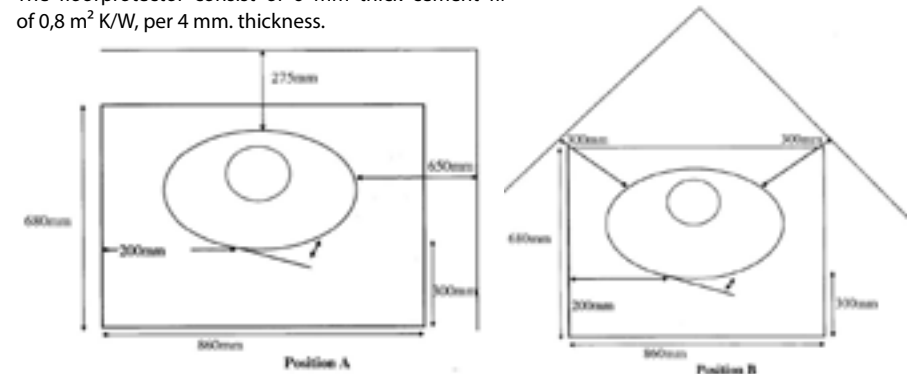

We recommend that the stove be installed at least 10-15 cm from masonry in order to allow heat to circulate and to facilitate the cleaning of the inside and outside of the stove. A layer of wallpaper on a brick wall is normally regarded as non-flammable material.

#### The floor

If the stove is installed on a flammable floor, national and local regulations must be observed with regard to the size of the heat resisting underlying surface that must cover the floor beneath the stove.

The floor protector (cement fibre or similar) must be installed so that its leading edge is a minimum of 300 mm in front of the appliance base. The floor protector must be a minimum of 860 mm wide x 680 mm deep x 6 mm thick. The floor protector must consist of 6 mm thick cement fibre sheet with a thermal resistance value of 0.8 m<sup>2</sup>K/W, per 4 mm thick sheet.

#### Distance to furniture

We recommend that the stove be installed 800 mm from furniture, but consideration should also be given to whether furniture, etc., will dry out as a result of its proximity to the stove.

The distance to flammable material in front of the stove is 800 mm.

A wood-burning stove gets hot when it is fired. Caution must therefore be observed, particularly with regard to children touching the stove.

### 1.5 The chimney

The Morsø 6600 have been tested with a 6" Hawkwind Triple Skin Flue Kit. Clearances quoted in the installation instruction can only be used when the Hawkwind Triple Skin Flue Kit or compliant 6" Decromesh Kit is used.

Caution: The appliance and flue system shall be installed in accordance with AS/NZ 2918 and the appropriate requirements of the relevant building code or codes.

Caution: Mixing of appliance or flue system components from different sources or modifying the dimensional specifications of components may result in hazardous conditions. Where such action is considered, the manufacturer should be consulted in the first instance.

Any modification of the appliance that has not been approved in writing by the testing authority is considered to be in breach of the approval granted for compliance with AS/NZ 4103.

If local regulations permit, the stove may be connected to a chimney already serving another fireplace (such as an oil-burning stove or another wood-burning stove). Attention should be paid to any requirements concerning the location of flue pipes if two or more fireplaces are connected to the same chimney.

The wood-burning stove must never be connected to a chimney to which a gas-burning stove is already connected. An efficient, modern stove places great demands on the chimney, so have a chimney sweep check the condition of your chimney.

The aperture of the chimney must comply with national and local regulations. In general, the aperture area should measure at least 175 cm<sup>2</sup> for wood-burning stoves.

An overly large chimney aperture will mean that too much energy will be required to heat the chimney sufficiently to achieve an acceptable draught. If you have a brick chimney with a large aperture, we recommend that you install an insulating chimney liner of the proper diameter. This will increase the draught, and improve the fuel economy.

There are no requirements with respect to specific chimney heights, but a chimney must be tall enough to provide a good draught, and to ensure that the smoke does not cause any problems. As a general rule, there will be a satisfactory draught if the chimney extends 4 metres above the stove and at least 80 cm above the spine of the roof. If the chimney is located along the side of the house, the top of the chimney should never be lower than the spine of the roof or the highest point on the roof.

Please note that there are often national and local regulations regulating the location of chimneys in houses with thatched roofs. Please see section 1.9 Draught.

The chimney and the flue pipe must be fitted with cleaning doors, which must be at least the same size as the chimney's aperture area.

The chimney must be accessible for external inspection, and it must be possible to access the cleaning doors and the chimney if it is to be cleaned from the top (e.g. steel chimneys).

### 1.6 Connecting the flue pipe

Lift the upper cast iron top plate off the stove

Note: the round cast iron cover plate in the top plate must remain in place if the stove is being installed with the flue pipe leading to the rear, and must be removed from the surface of the top plate if you wish to install the flue pipe leading upwards.

The cast flue collar fits a 150 mm diameter flue pipe.

Fitting the flue collar for leading upwards.

The stove has been prepared in the factory, for the installation of the flue collar (1) leading upwards, using the screws provided

Fitting the flue collar leading out to the rear

If you wish to fit the stove with the flue at the back, unscrew the sheet metal cover off the back of the stove. This cover is then screwed onto the inside of the stove's top plate. The flue collar should then be centered and screwed firmly onto rear side of the stove.

Positioning of the smoke baffle and the smoke hood

The Vermiculite baffle kit (3) is positioned on reception. Take the kit out of the stove. The cast iron smoke hood (2) which is despatched unattached inside the stove, should be lifted up and screwed into place so that it is centered and locks into the 2 cast forks. The Vermiculite baffle kit (3) should then be positioned back into the two recesses in the sides and pushed backwards against rear fire brick.

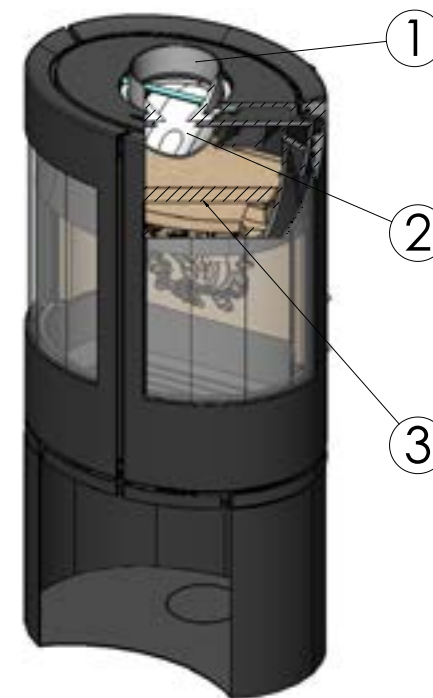

Morsø 6600

Please make sure that the smoke baffles are correctly fitted before proceeding to light the stove.

### 1.7 Connecting to a brick chimney

Brick a flue bushing securely into the wall, and insert the flue pipe into it. The pipe must not extend into the actual chimney opening, but only to the inside of the chimney aperture. The joints between the stove/pipe and pipe/wall bushing must be sealed with the glass tape provided. It is not normally necessary to seal between any pipe joints.

If the flue pipe transitions from horizontal to vertical, it is a good idea to install it with a gentle bend so as to avoid any loss of draught.

The flue pipe must be dimensioned in accordance with national and local regulations. Morsø recommends, however, that flue pipes be made of 2 mm sheet steel as this will extend the service life.

### 1.8 Connecting to a steel chimney

If your installation involves routing the chimney straight up through the ceiling, it must comply with national and local regulations concerning the distance of the chimney from flammable ceiling material. The chimney must be sealed at the smoke outlet using the glass tape provided. It is important to install the chimney with a roof support so that the stove does not bear the weight of the chimney. (See the chimney manufacturer's instructions). Heavy weights on the stove's top plate may cause it to crack. The Morsø warranty does not cover the top plate if the chimney is installed without a roof support.

If a chimney fire should occur as a result of incorrect operation of the stove or prolonged use of wet fuel, close the vents completely and contact the fire brigade.

#### Be aware of the following:

Discuss the cleaning options with your chimney sweep.

If there is insufficient draught in the chimney, it may be a good idea to install the flue pipe straight up so as to minimise smoke migration in the actual combustion chamber.

Avoid having more bends than necessary, and limit the length of the flue pipe so as not to reduce the draught.

#### Fresh air supply

A wood-burning stove requires air for combustion. As a result, firing a wood-burning stove will help create a healthy climate in your house. If the house is very tightly sealed, and particularly if there is a cooker hood or ventilation system in the house, it may be necessary to install an air grate in the room in which the wood-burning stove is installed. Otherwise there may not be enough draught in the chimney, which may result in the stove not being able to burn properly, and smoke may come out of the stove when the fire door is opened.

If it is necessary to install air grates, they must be positioned so that they cannot be obstructed.

### Installation of wall-mounted Morsø 6600

The wall-mounting frame has holes for mounting expansion bolts into the wall.

The wall-hung Morsø 6600 must not be mounted on a wall made of combustilbe materials.

The bolts must be adequately sized and you must ensure that the wall is capable of supporting the stove. The weight of the empty stove is approx. 120 kg

It is therefore the responsibility of the installation contractor/customer to make sure that the wall/chimney can support the stove securely. We point out that element block chimneys and semi-brick chimneys without a lining do not always have the necessary carrying capacity. If in doubt, you should contact a professional craftsman. The wall mounting frame may be used as a template for drilling.

Note: Plastic rawlplugs must not used due to the heat produced by the stove.

Minimum distance to combustible floor is 360 mm.

Mount the wall-mounting fixture on the wall. If the flue exit is wanted to the rear, build a wall bushing correctly into the wall.

Lift the wood stove in place so that it rests on the bottom part of the wall-mounting fixture, and secure it again to the fixture by means of the screws included.

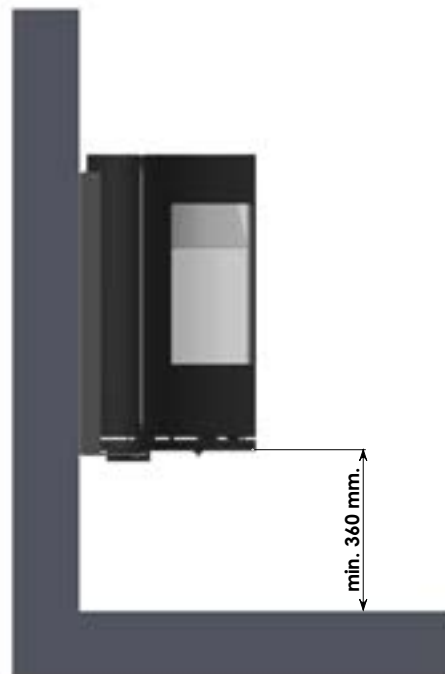

Morsø 6600

## 1.9 Draught

If smoke comes out of the stove when the fire door is opened, it will be due to the poor draught in the chimney. This type of stove requires at least 12 Pascals of chimney draught to achieve satisfactory combustion and to prevent smoke from escaping. Smoke may, however, escape in any event if the stove door is opened during vigorous firing, so this should be avoided.

If in doubt, you may want to get your chimney sweep to measure the draught in the chimney.

### Draught

The draught in the chimney is the result of the difference between the high temperature in the chimney and the cooler temperature outside. Other factors that determine whether sufficient negative pressure can be produced to create a draught include the length and insulation of the chimney, and wind and weather conditions.

#### The draught will be reduced when:

- The temperature difference is too low, e.g. in connection with a poorly insulated chimney.  
If the chimney is cold, it may help to light (burn up) a rolled-up newspaper in the chimney's cleaning door.
- The outside temperature is too high, e.g. during the summer.
- There is no wind.
- The chimney is not tall enough, with the result that it sits in the lee of the roof surface or tall trees.  
These conditions are also associated with the greatest risk of smoke coming back down the chimney.
- Air is entering the chimney in undesired places, e.g. through cracked joints or leaks in the cleaning door or the flue pipe.
- Unsealed, unused fireplaces are connected to the chimney.
- The flue pipe and chimney are clogged up with soot due to inadequate cleaning.
- The house is too tightly sealed (please see the section on Fresh air supply).

#### A good draught is achieved when:

- There is a big difference between the temperature in the chimney and outside, i.e. when the need for heating is greatest.
- The weather is clear and there is a good wind.
- The chimney is of the proper height, i.e. Minimum 4 metres above the stove, and clear of the spine of the roof.

## 2.0 Firing/using the stove

Your stove is constructed with air inlets in three places.

Pre-heated primary combustion air from beneath the grate. This combustion air should only be used during start-up and only if chimney conditions is bad or the fuel is a bit moist. The primary air is supplied when the lowest lever at the rear of the stove is slid in the direction away from the stove.

A second pre-heated, fast-moving combustion air is added to the fire above the glass window. The controller handle (upper) for this combustion air is placed on the back of the stove. The combustion air is supplied when the handle is pushed in the direction away from the stove and is closed when the handle is pushed toward the stove.

A third air inlet provides a constant, pre-heated air supply which cannot be adjusted, and which comes into the combustion chamber just above the fire. This helps to burn off the last few gases emitted by the wood whilst it is being heated up.

### N.B!

Wood is a material that contains a great deal of gas (approximately 75 %). The gases are released when the wood is lit and heated up. For this reason, it is important that the gases are ignited quickly after stoking. If the wood just lies smouldering, especially after re-stoking, a lot of smoke is created, which, in the worst case, may cause an explosive ignition of the gasses, resulting in damage to the stove.

In order to ignite the gases that are released from the wood, and to keep clear, lasting flames during the combustion process, it is important to let in the required quantity of oxygen (air supply) at all times. The setting of the air supply, the method of ignition and the lighting intervals depend on the draught in the chimney, the wind and weather, the amount of heat required, the fuel, etc. This means that it may take some time before you get to know the correct functioning of the stove under any given circumstances.

Although you can fire your Morsø stove with almost all kinds of wood, you should not fire with wet wood, or unseasoned wood. Wood ought to be stored under a roof for at least 1 year, and preferably 2 years, with free access to wind. Wood should be chopped as soon as possible after felling if it is to dry quickly. The wood can be used once the moisture content is less than 20%.

Never use driftwood, as it usually has a high salt content, which damages both the stove and the chimney. Impregnated and painted wood and chipboard emit poisonous smoke and fumes, so they should not be used as fuel either.

Please note that liquid fuel may not be used in the stove.

Pieces of wood with a diameter greater than 10 cm should always be chopped.

The pieces of wood should be short enough to be able to lie flat over the layer of embers, with air at both ends.

The maximum length of fuel in the stove is 30 cm.

The maximum quantity of fuel is 2 kg/hour (max. 2 pieces of wood each time you re-stoke).

The first few times you light the stove, the fire should be moderate, so that the heat-resistant paint can harden before firing more vigorously. During the hardening phase, the paint may develop obnoxious smoke and smell the first time it is lit, which is very normal. Make sure that the room is well ventilated during this period.

When heating up or cooling down, the material is exposed to major temperature differences that may cause the stove to give off creaking sounds.

## 2.1 Lighting and fuelling intervals

A lot of air is needed when lighting the stove. If you are starting with a cold stove, the door should be left ajar for the first few minutes, and the combustion air supply opened to maximum. Always keep a couple of centimetres of ash in the bottom of the combustion chamber. This will have an insulating effect, and ensures good combustion.

1. A layer of embers will form rapidly if the stove is lit with 2 fuel tablets or 7 - 10 rolled up sheets of newspaper underneath 1.5 kg of dry kindling. It is important to start up carefully, so that combustion builds up slowly. This minimizes soot formation on the glass. Soot formation on the glass is often caused by too vigorous burning in contact with cold surfaces. If you avoid the formation of soot when lighting the fire and build up a layer of hot embers, you will have minimal soot formation when getting the fire burning again later.



2. Open the air supply as much as possible. To fully open the secondary air supply, use the top damper at the back of the stove. The combustion air is supplied when the handle is pushed in the direction away from the stove. Lower control lever controls the primary combustion air (lower air supply air). This is only used during startup and only if there are unfavourable conditions such as poor chimney draft or slightly damp wood. One should avoid using primary air if it is not necessary, as it often leads to increased pollution and can cause sooty windows

3. After the paper/solid alcohol tablets have caught fire, leave the fire door ajar, so that the chimney draws well.



4. When you can see that the chimney is hot enough to draw (after 5 - 10 minutes), close the door. If all the necessary conditions are met, a thick layer of embers will have been formed in the combustion chamber after another 15 - 20 minutes, and there will be a high temperature in the combustion chamber, which is necessary in order to be able to continue the combustion.



5. If the condition in step 4 is met, place max. 2 pieces of wood with a total weight of 1.5 kg and a length of 25-30 cm over the embers in a single layer, with a distance of approximately 1 cm.



6. Open the air supply to maximum, and close the door. The fresh wood will be lit within 1-3 minutes. If it does not light, open the door slightly to allow in enough air to ignite the wood. Close the door again once the wood has caught fire.

7. Reduce the amount of combustion air to the desired position, and the optimal combustion will continue. Make sure that there is always enough air (oxygen) to maintain clear, lasting flames when, and after, reducing the amount of combustion air.

Make sure that there is always enough air (oxygen) to maintain clear, lasting flames when, and after, reducing the amount of combustion air.

The stoking interval is between 45-75 minutes.



8. Once the fire has been reduced to a thick layer of embers, a new portion of wood can be added by repeating steps 5 & 7.

### Important!

It is important that the fresh quantity of wood starts to burn quickly. To ensure the fuel lights quickly, open the combustion air to max. or leave the door ajar to allow in the amount of air needed to light the wood.

If, however, the wood only smoulders, there will be a strong build-up of smoke, which at worst can cause an explosive ignition of the flue gases with the risk of material damage and personal injury.



The stove door should normally be opened gently the first 2-3 cm, then you should wait until the pressure has equalised before opening the door all the way. This technique will prevent smoke from getting out, particularly when there is a poor draught.

The stove door should never be opened when the stove is being fired vigorously.

Once the wood has burned out, it becomes glowing charcoal. If a good layer of embers has already formed on top of a sufficient layer of ash, the stove can keep warm for a very long time, not least due to the favourable qualities of the cast iron.

We would strongly recommend that you do not leave your stove alit at night. It harms the environment and constitutes very poor use of the wood as the gases in the wood do not ignite at the low temperature, but settle as soot (unburned gases) in the chimney and stove. Extreme conditions, such as poor draught in the chimney, large quantities of wood or wet wood, may in the worst-case scenario cause an explosive ignition.

When firing in the summer period, when there is minimal need for heat, the combustion will be poor. The stove provides too much heat so the combustion should be reduced. But always remember to make sure that there are lasting flames until the wood becomes charcoal. If you want a weaker fire, stoke up using less wood.

If you fire the stove using wet wood, a lot of the fuel's thermal energy will be spent forcing the water out of the wood, without releasing any heat to the stove. This incomplete combustion results in a layer of soot being left in the stove, pipe and chimney.

Comparison between firing with wood and oil:

Type of wood (moisture content 20%)	No. of cubic metres per 1000 l oil
Oak	7.0
Beech	7.0
Ash	7.2
Sycamore	7.5
Birch	8.0
Elm	8.9
Common spruce	10.4
Silver fir	10.9

#### Fuel Type

Refer to compliance label the stove's rated heat output is 7.0kW.

Your new Morsø stove is AS/NZS-tested for firing with hard wood, and is suitable for intermittent use.

## 3.0 Routine stove maintenance

### 3.1 External maintenance

The cast surface of the stove is painted with heat-resistant Senotherm paint. It is best maintained by simply vacuuming it with a soft brush attachment or wiping it down with a dry, dust-free cloth.

If the stove is used too vigorously, the painted surface may assume a greyish tinge over time, but the stove can easily be freshened up with Morsø spray paint, which is available from your local retailer.

Morsø stoves are painted using a Morsø Original Black (previously called Morsø dark grey) or Morsø grey. The paint can be bought in a spray or a can.

### 3.2 Internal maintenance

#### Glass window

If the stove is used correctly, very little or no soot will be deposited on the ceramic glass window. If soot does form on the glass as the stove is being lit, it will burn away once normal combustion begins in the stove. If the glass window becomes thoroughly covered in soot due to incorrect operation, the soot can be easily removed using a cleaning agent such as Morsø Glass Cleaner. The glass must be cold when you clean it. Avoid stoking the stove with pieces of wood that are so long that they press against the glass window when the door is closed.

#### Reasons for sooty glass window:

- The fuel is too wet.
- The pieces of fuel are too big/uncut wood.
- The combustion temperature is too low.

#### Ceramic glass replacement

Ceramic glass cannot be recycled because it has a higher melting point than ordinary glass. If ceramic glass is mixed with ordinary glass, the raw material is spoiled, and the reclaiming process may be halted. Take care that the ovenproof glass does not end up among ordinary recycled waste. That will be a great benefit to the environment.

Note: Should be handed in to a recycling station as ceramic glass.

#### Internal cast-iron parts and/or wearing parts

The baffles and other components that come in direct contact with the fire and glowing fuel are all wearing parts. As a result, they will be particularly susceptible to burn-through. When used correctly, these parts will last for many years, but overly vigorous use will naturally accelerate the burn-through. Such parts are all easily replaced. If the baffles are damaged and are not replaced in time, the top plate will be exposed to such high temperatures that it may be damaged as well.

Please note that no unauthorised alterations of the design may be undertaken, and that any parts that are replaced must be replaced with original Morsø parts.

#### Reasons for overly rapid wear of internal parts

- Stove fired too vigorously
- Use of very dry wood (wood from old furniture).
- Too much soot on top of the baffles (please see the section on Cleaning).
- Too much ash in the ash pan (please see the section on Ash).

#### Gaskets

The gaskets in the doors will wear out over time and should be replaced as required in order to prevent runaway combustion. Use the original Morsø gasket kit.

Note: Normal wearing parts are not covered by Morsø's extended warranty.

A selection of maintenance products (spare parts, glass cleaner, paint, gasket kit, etc.) is available from your Morsø dealer.

### 3.3 Cleaning the stove

A layer of ash and soot will form as a result of the draught in the chimney and after sweeping, particularly on the top of the upper baffle. This ash will have an insulating effect, which may speed up the burn-through of the baffles.

During normal cleaning, the baffles can be removed from the stove. Once the baffles have been taken out, you can access the flue chamber above the baffles and clean it.

Clean the baffles before reassembling them, and make sure that they are correctly assembled.

Nowadays, the chimney sweep must remove the soot in the stove, in addition to sweeping the chimney and cleaning the flue pipe. The number of annual sweepings/cleanings of the stove should be determined in consultation with your chimney sweep.

#### Ash

As noted above, there should be a layer of approx. 1 cm insulating ash in the bottom of the combustion chamber in order to achieve a high combustion temperature. If the layer of ash is too thick, it can be brushed down into the ash pan.

Empty the ash pan before it gets completely full so that the ash does not insulate around the grate, and thereby speed up the burn-through.

In most cases, the ash will need to be taken away by the waste disposal company. Because embers may be concealed in the ash pan for several days, it may be necessary to store the ash in a container made of non-flammable material before pouring it into a rubbish bag.

Ash from a wood-burning stove will not be of any benefit to your garden as fertiliser. If you have burned colour brochures, or painted or treated wood, etc., in the stove, the resulting ash must not be poured onto soil as it may contain heavy metals.

## Spare parts for the 6600

Description	Product no.
Cast grate	34665600
Cast smoke hood	44661800
Vermiculite baffle, upper 6600	79667600
Vermiculite baffle 6600	79667300
Glass windows	79669000
Rear vermiculite brick 6600	79667200
Vermiculite side brick, right 6600	79667000
Vermiculite side brick, left 6600	79667100



**PARTICULATE EMISSIONS POWER OUTPUT AND EFFICIENCY TESTING OF THE MORSO 6643,6670 FREE-STANDING SOLID FUEL APPLIANCE**

**Report**

The Morso 6643,6670 Free-Standing solid fuel appliance was tested for particulate emissions power output and efficiency according to the requirements of the joint Australian/New Zealand Standard AS/NZS 4012/4013 (2014).

The appliance particulate emissions factor was 1.5g/kg of hardwood that complies to AS/NZS 4014.1, and the average efficiency of the appliance for all burn rates was 64%.

The Morso 6643,6670 Free-Standing solid fuel appliance complies with the requirements of AS/NZS 4012/4013 (2014).

**Investigation:** A. Reid & S. Marland

**Report:** S. Marland

**Checked by:** A. Reid

Signed:   
A. Reid  
Technical Officer

Approved:   
S. Marland  
Group Leader, Energy & Greenhouse Div. Mowwell

**THERMAL CLEARANCE TESTING OF THE MORSO 6643,6670 FREE-STANDING SOLID FUEL APPLIANCE INSTALLED WITH A 6 INCH TRIPLE SKIN (DEFAULT) FLUE KIT**  
**Report**

The appliance and flue system were installed into a Clearance Test enclosure and tested in two positions in a manner conforming to joint Australian/New Zealand Standard 2918:2001, Appendix B. A minimum 680mm deep x 860mm wide x 6mm thick floor protector (cement fibre sheet) should be used under and in front of the appliance base when installing the appliance (see joint AS/NZS 2918:2001 3.3.2). The floor protector should extend 300mm in front of the appliance base. The Thermal conductivity of the floor protector is 0.8m<sup>2</sup>K/W, per 4mm thick sheet.

The Morso 6643,6670 Free-Standing solid fuel appliance installed with a 6 inch triple skin (default) flue kit conforms to the requirements of the joint AS/NZS 2918:2001 Standard, Appendix B, with respect to rear wall, side wall, floor and ceiling surface temperatures, when tested in the positions described in this report and using *Pinus radiata* firewood as the fuel type.

**TEST POSITIONS**

The appliance and flue combinations were tested at the following clearances:

**Position A (Parallel)**

- 275mm from rear wall to the edge of the appliance rear panel.
- 650mm from side wall to the edge of the appliance side panel.

**Position B (Corner)**

- 300mm from walls when measured from the closest points of the appliance (45° to both walls).

Refer to Appendix 1 of this report for clearance diagrams.

**Investigation:** A. Wood  
**Report:** S. Marland  
**Checked by:** A. Reid

Signed:   
A. Reid  
Technical Officer

Approved:   
S. Marland  
Group Leader, Energy & Greenhouse Div.

**APPENDIX 1:  
MINIMUM CLEARANCES FOR THE MORSO 6643,6670 FREE-STANDING SOLID  
FUEL APPLIANCE INSTALLED WITH A 6 INCH TRIPLE SKIN (DEFAULT) FLUE  
KIT**

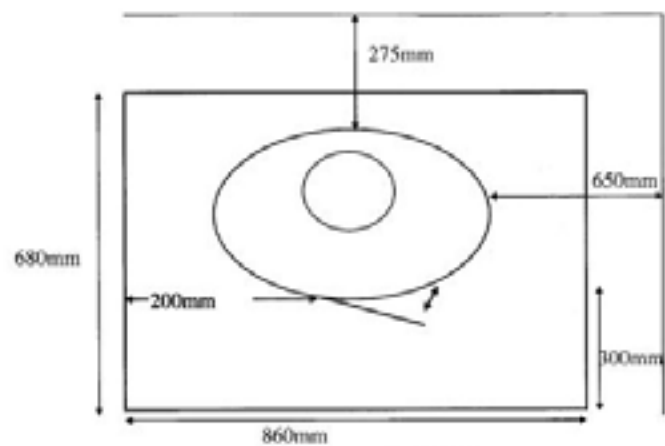

**Position A**

The floor protector consisted of 6mm thick cement fibre sheet which had a thermal resistance of 0.8m<sup>2</sup>K/W, per 4mm thick sheet

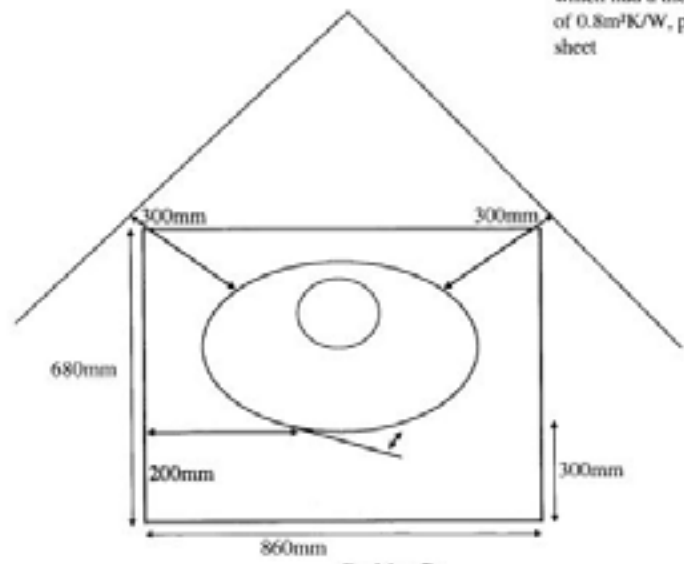

**Position B**



Morsø Jernstøberi A/S - 24.02.2015 - 72664600